

NEW XL<sup>3</sup> 125 CABINET

Now it's  
so easy



UP TO 125 A

1 TO 4 ROWS OF 18 MODULES

 **legrand**<sup>®</sup>

# Optimised wiring for maximum ease of installation and time-saving

## WIRING ON-SITE

The XL<sup>3</sup> 125 cabinet makes on-site installation easy, with the 3 functions opposite:



### I Tool-free removable rail

Rails can be removed individually in a single movement, and without any tools, for easier cable routing.

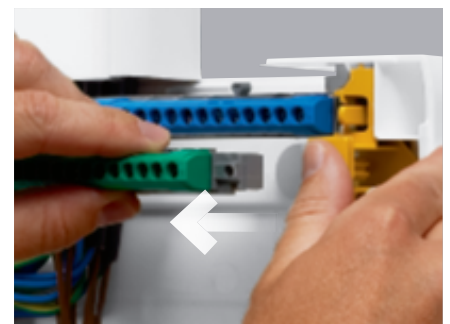

### II Plug-in earth terminal block

Tool-free removal of the earth terminal block for easier cable routing.



### III Removable cable entry plate

The cable entry plate can be removed without using any tools, to allow direct cable entry.

## WIRING ON-SITE (CONTINUED)

Cable connection is easy, simply tilt the chassis up or down according to the direction of cable entry.



### Tool-free pivoting chassis

Unlock the chassis with a single action - no tools required.



### Integrated fittings for cable ties

Cables can be anchored without any additional accessories. The fittings for cable ties are incorporated at the back of the cabinet, saving both time and materials.

## WIRING IN THE WORKSHOP

You can also prepare your installation flat with the chassis out of the cabinet.



# Easy to install, maintain and use

02

## EASY ACCESS

The faceplate can be removed one row at a time, or the whole cover can be taken off, depending on the extent of the work to be carried out inside the cabinet: wiring or maintenance.



OR



## ALIGNING THE COVER

Positioning the cover is simplicity itself. The alignment system ensures the cover is correctly positioned in relation to the back of the cabinet, preventing incorrect fitting.



### Faceplate

The faceplate can be removed one row at a time; fixed with 1/4 turn screws.



### RAIL/FACEPLATE MARKING

Each rail and each faceplate can be marked for easy positioning on the chassis or for quicker re-assembly after maintenance.

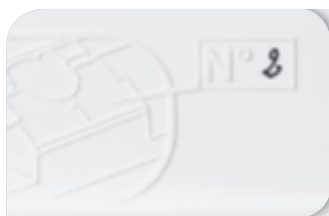

#### Faceplate marking

Each faceplate can be marked for even faster mounting.



#### Rail marking

Each rail can be marked for easy positioning on the chassis.

### CABLE ENTRY PLATE

The cable entry plate can be removed in a single action. With the various markings and cut-outs you can adjust the wall trunking entry point in the cabinet.

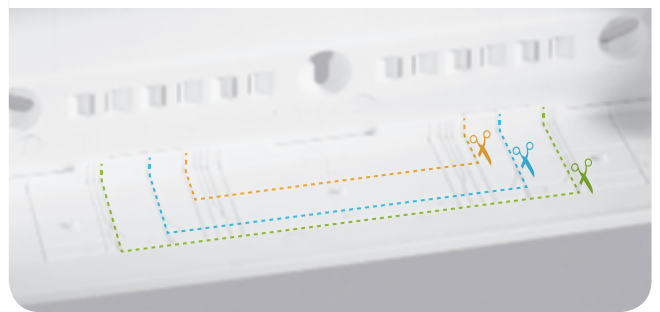

The cabinet is compatible with the most commonly used sizes of wall trunking available on the market



# Easy to install, maintain and use (continued)

## FULLY REVERSIBLE

The base, chassis, faceplate and door are all fully reversible, ensuring you have a faultless finish whatever the location.



## TOTAL FLEXIBILITY WHEN FITTING THE DOOR

The door has a temporary fixing system to make installation as easy as possible.



### Temporary fixing

The door hinges are simply clipped onto the cover.



### Awaiting final fixing

The door is held in place with no additional support before it is finally fixed with screws.



### Final fixing

It is finally fixed by screwing in the 2 cover screws.

### FIXING CENTRES MARKED

The fixing centres (horizontal and vertical) are marked directly on the base of the cabinet. No need for any additional drilling template.



### CHOICE OF MOUNTING

The fixing holes are pre-cut and positioned so that it is easy to adjust the position of the cabinet on the wall.

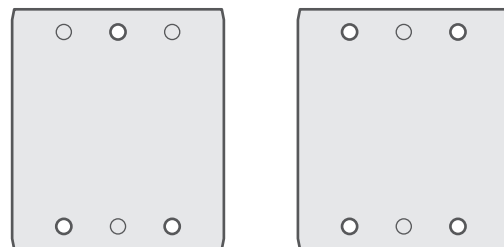

"Hanging" fixing (1 point in the centre, 2 points at the bottom), adjustable "peripheral" fixing (4 fixing points).

### DOCUMENT HOLDER

The self-adhesive document holder can be fixed directly on the cabinet's bottom faceplate.



### MARKING THE CIRCUITS

Each circuit can be clearly marked on the faceplate using the self-adhesive labels supplied with the cabinet.



# Total adaptability for your projects up to 125 A

06

## EQUIPMENT IN THE CABINET



XL<sup>3</sup> 125 cabinets are designed to be suitable for the widest variety of applications on your sites in the residential and small business sectors. They can take a wide range of equipment, such as:

- DPX 125 MCCBs
- Signis control units
- Mosaic sockets



**Modular equipment**  
Modular equipment can be fixed directly on the DIN rails in the cabinet.



**DPX 125**  
DPX 125 MCCBs can be fixed on the DIN rail, placed in a low position.



**Control units**  
The plain faceplate can take Signis control and signalling units.



**Perforated plate**  
The perforated plate is used for easy integration of non-modular equipment (electronic control box).



**Mosaic™ wiring accessories**  
The optional fixing accessory enables Mosaic mechanisms to be incorporated on either side of the cabinet.



**VERTICAL OR HORIZONTAL JOINING SYSTEM**

It is easy to expand the capacity of the consumer unit with the joining kit which can be used to join cabinets horizontally or vertically.



Joining kit (horizontal or vertical)

**NEAT DESIGN**



**Handle**  
Integrated handle, door snaps shut. Can be locked using the optional key lock.

**Doors**

The doors are available in opaque or transparent versions for perfect integration in all locations.



Horizontal joining of two cabinets of the same capacity



Vertical joining of two different capacity cabinets



# XL<sup>3</sup> 125

surface mounting distribution cabinets from 18 to 72 modules



**Technical characteristics (see opposite)**

IP 40 - IK 09 with door  
 IP 30 - IK 09 without door  
 Class II  
 Self-extinguishing: resistance to incandescent wire 650°  
 Conform to IEC 60439-3 and IEC 60670-24

Pack	Cat.Nos	<b>Surface-mounting distribution cabinets</b>				
		Capacity 18 modules per row White RAL 9003 Fully reversible cabinet (base, door and faceplates) Supplied with: - removable and pivoting chassis with  rails fitted. Rails can be individually removed for easy cabling on site - removable cable entry plate (top and bottom) - removable faceplates (for each row) - IP 2X screw terminal blocks for neutral and earth - blanking plates (5 modules, separable per module or 1/2 module) - 1 sheet of self-adhesive labels for circuit identification (marking per module) Spacing between rails 150 mm Adjustable  rail (2-position) for fitting modular equipment or DPX 125 moulded case circuit breakers Can be fitted with perforated plates and solid faceplates for mounting non-modular products (2, 3 to 4-row cabinets) Doors to be ordered separately				
		Number of rows	Number of modules	Height (mm)	Width (mm)	Depth (mm)
1	4016 76	1	18	300	450	128
1	4016 77	2	36	450	450	128
1	4016 78	3	54	600	450	128
1	4016 79	4	72	750	450	128

Pack	Cat.Nos	<b>Accessories</b>	
2	4018 51	<b>Key lock</b>	To be fitted on white or transparent doors Supplied with key N° 850
2	4018 45	<b>Horizontal or vertical joining kit</b>	For joining 2 cabinets
1	4018 56	<b>Fixing lugs</b>	Set of 4 wall fixing lugs
2	4018 44	<b>Document holder</b>	Self-adhesive document holder for plans To be fitted on the cabinet
20	016 60	<b>Blanking plates</b>	Separable per module or 1/2 module 5 modules - white RAL 9003
2	4018 55	<b>Plain faceplates</b>	For 2, 3 or 4-rows cabinets Allow fitting of non-modular equipments such as control and signalling units
1	4018 53	<b>Perforated plates</b>	To be used instead of the one  rail when integrating non-modular products For 18 modules cabinets. Height 150 mm
5	4018 50	<b>Fixing accessory for Mosaic wiring devices</b>	For fixing 2-module mechanisms on the side of the cabinet

<b>Doors - IP 40 - IK 09</b>	
	For XL <sup>3</sup> 125 distribution cabinets Fully reversible Can be equipped with lock and key n° 850 Cat.No 4018 51
	<b>White RAL 9003</b>
1	4018 61 For distribution cabinet Cat.No 4016 76
1	4018 62 For distribution cabinet Cat.No 4016 77
1	4018 63 For distribution cabinet Cat.No 4016 78
1	4018 64 For distribution cabinet Cat.No 4016 79
	<b>Transparent</b>
1	4018 71 For distribution cabinet Cat.No 4016 76
1	4018 72 For distribution cabinet Cat.No 4016 77
1	4018 73 For distribution cabinet Cat.No 4016 78
1	4018 74 For distribution cabinet Cat.No 4016 79

# XL<sup>3</sup> 125

surface mounting distribution cabinets from 18 to 72 modules

## Number of connections per neutral and earth terminal block (supplied with enclosure)

Enclosure Cat.Nos	Neutral terminal blocks Screw connection		Earth terminal blocks Screw connection	
	6 - 25 mm <sup>2</sup>	1.5 - 16 mm <sup>2</sup>	6 - 25 mm <sup>2</sup>	1.5 - 16 mm <sup>2</sup>
4016 76	1	17	1	17
4016 77	1	21	1	21
4016 78	1	26	1	26
4016 79	1	34	1	34

## Number of blanking plates supplied per enclosure

Enclosure Cat.Nos	Number of blanking plates 5 modules
4016 76	1
4016 77	2
4016 78	3
4016 79	3

## Dimensions

Front view

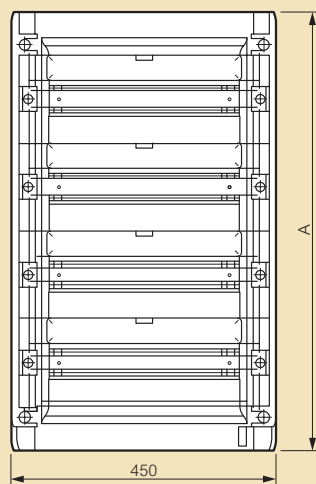

Side view without door

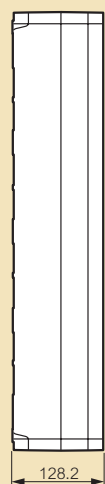

Side view with door



Fixing centres and distance between rails

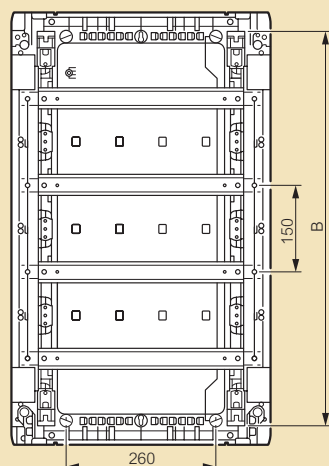

Enclosure Cat.Nos	A (mm)	B (mm)
4016 76	300	250
4016 77	450	365
4016 78	600	515
4016 79	750	665

## Removable and pivoting chassis

Removable chassis

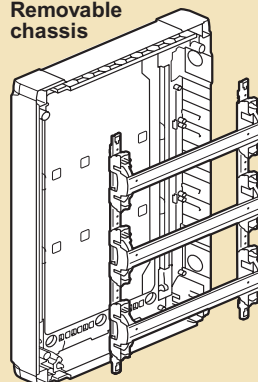

Removable rail

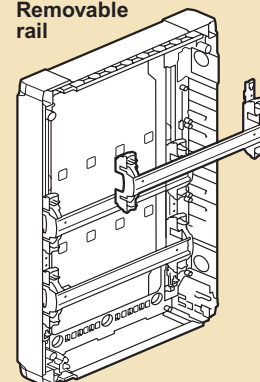

Pivoting chassis

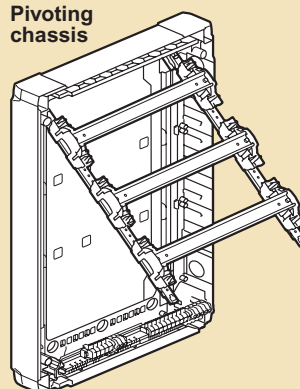

## Removable cable entry plate

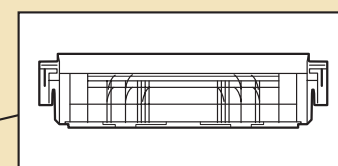
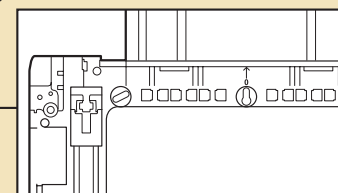
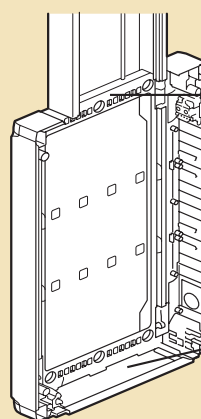

Pre-cut cable entry plate for different sizes of trunking

## Removable faceplate

Cabinet with rails, perforated plate, faceplates for DIN-rail equipment and plain faceplate

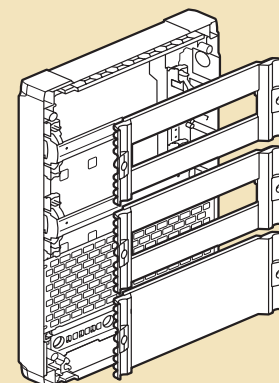
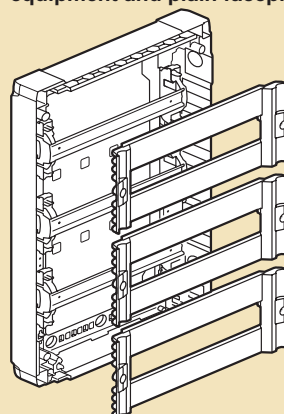



**World Headquarters  
and International Department**

128, av. du Maréchal-de-Lattre-de Tassigny  
87045 Limoges Cedex - France  
☎: + 33 (0) 5 55 06 87 87

email: [direction-export.limoges@legrand.fr](mailto:direction-export.limoges@legrand.fr)

[www.legrandgroup.com](http://www.legrandgroup.com)